

SERIE G400

Cerniera per montaggio su telaio esterno



Hinge to mount on an external frame
 Scharnier für Montage auf Außenrahmen
 Bisagra para montaje sobre bastidor externo
 Charnière pour montage sur châssis extérieur

Regolabile lateralmente $\pm 1,5$ e ± 3 mm per mezzo bussola bandella
 It can be adjusted $\pm 1,5$ e ± 3 mm laterally via strap bushing
 Seitlich einstellbar $\pm 1,5$ und ± 3 mm durch Beschlagsbüchse
 Regulable lateralmente $\pm 1,5$ y ± 3 mm por medio de casquillo de rotación pletina
 Réglable latéralement $\pm 1,5$ e ± 3 mm par douille penture



Cerniera

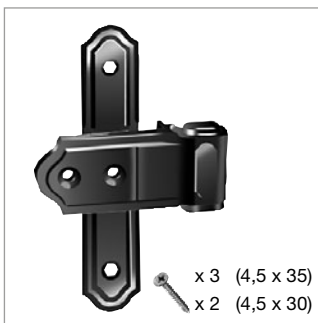

Hinge
 Scharnier
 Bisagra
 Charnière

Codice	Dimensione			Nero	RAL 9016	Pcks
G400-10	F1	2,5	16	S562A210 502	S462A21W 537	10



Cerniera con bandella a croce

Hinge with cross strap
 Scharnier mit Kreuzband
 Bisagra con pletina en cruz
 Charnière avec penture en croix

Codice	Dimensione			Nero	RAL 9016	Pcks
G400-20	F1	2,5	16	S562A230 502	S462A23W 537	10



Cerniera con squadretta 220x220 (set)



Hinge with square
 Scharnier mit Befestigungswinkel
 Bisagra con escuadrilla
 Charnière avec petite équerre

Codice	Dimensione			Nero	RAL 9016	Pcks
G400-30	F1	2,5	16	S562A250 502	S462A25W 537	5 + 5



Cerniera con bandella lunga

Hinge with long strap
 Scharnier mit langem Band
 Bisagra con pletina larga
 Charnière avec penture longue

Codice	Dimensione			Nero	RAL 9016	Pcks
G400-40	F1/320	2,5	16	S562A290 502	S462A29W 537	10